



MOTOROLA

128 X 8-BIT STATIC RANDOM ACCESS MEMORY

The MCM6810 is a byte-organized memory designed for use in bus-organized systems. It is fabricated with N-channel silicon-gate technology. For ease of use, the device operates from a single power supply, has compatibility with TTL and DTL, and needs no clocks or refreshing because of static operation.

The memory is compatible with the M6800 Microcomputer Family, providing random storage in byte increments. Memory expansion is provided through multiple Chip Select inputs.

- Organized as 128 Bytes of 8 Bits
- Static Operation
- Bidirectional Three-State Data Input/Output
- Six Chip Select Inputs (Four Active Low, Two Active High)
- Single 5-Volt Power Supply
- TTL Compatible
- Maximum Access Time = 450 ns – MCM6810
360 ns – MCM68A10
250 ns – MCM68B10

ORDERING INFORMATION

Speed	Device	Temperature Range
1.0 MHz MIL-STD-883B MIL-STD-883C	MC6810P, L	0 to 70°C
	MC6810CP, CL	-40 to +85°C
	MC6810BJCS MC6810CJCS	-55 to +125°C
1.5 MHz	MC68A10P, L	0 to +70°C
	MC68A10CP, CL	-40 to +85°C
2.0 MHz	MC68B10P, L	0 to +70°C

MCM6810
1.0 MHz
MCM68A10
1.5 MHz
MCM68B10
2.0 MHz

MOS
(N-CANNEL, SILICON-GATE)
**128 X 8-BIT STATIC
RANDOM ACCESS
MEMORY**

P SUFFIX
PLASTIC PACKAGE
CASE 709

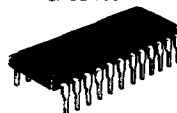

L SUFFIX
CERAMIC PACKAGE
CASE 716

PIN ASSIGNMENT

1	Gnd	0	VCC	24
2	D0		A0	23
3	D1		A1	22
4	D2		A2	21
5	D3		A3	20
6	D4		A4	19
7	D5		A5	18
8	D6		A6	17
9	D7		R/W	16
10	CS0		CS5	15
11	CS1		CS4	14
12	CS2		CS3	13

**M6800 MICROCOMPUTER FAMILY
BLOCK DIAGRAM**

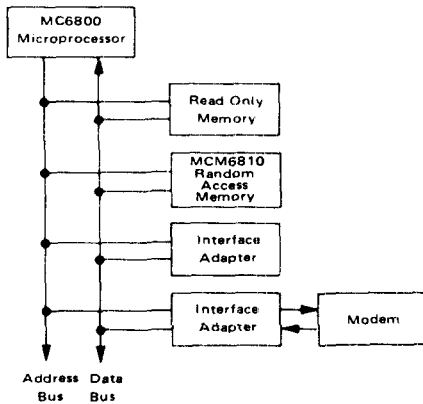

**MCM6810 – RANDOM ACCESS MEMORY
BLOCK DIAGRAM**

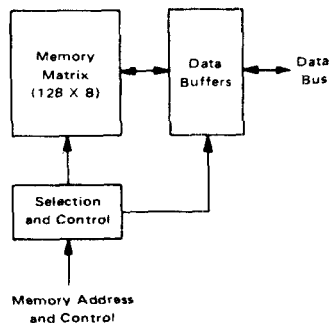

MCM6810

MAXIMUM RATINGS

Rating	Symbol	Value	Unit
Supply Voltage	V_{CC}	-0.3 to +7.0	Vdc
Input Voltage	V_{in}	-0.3 to +7.0	Vdc
Operating Temperature Range	T_A	T_L to T_H 0 to 70 -40 to 85 -55 to 125	$^{\circ}C$
Storage Temperature Range	T_{stg}	-65 to +150	$^{\circ}C$
Thermal Resistance	θ_{JA}	82.5	$^{\circ}C/W$

This device contains circuitry to protect the inputs against damage due to high static voltages or electric fields; however, it is advised that normal precautions be taken to avoid application of any voltage higher than maximum rated voltages to this high impedance circuit.

ELECTRICAL CHARACTERISTICS ($V_{CC} = 5.0\text{ V} \pm 5\%$, $V_{SS} = 0$, $T_A = T_L$ to T_H unless otherwise noted.)

Characteristic	Symbol	Min	Typ	Max	Unit
Input Current (A_n , R/W, \overline{CS}_n , \overline{CS}_n) ($V_{in} = 0$ to 5.25 V)	I_{in}	-	-	2.5	μA
Output High Voltage ($I_{OH} = -205\ \mu\text{A}$)	V_{OH}	2.4	-	-	Vdc
Output Low Voltage ($I_{OL} = 1.6\ \text{mA}$)	V_{OL}	-	-	0.4	Vdc
Output Leakage Current (Three-State) ($CS = 0.8\ \text{V}$ or $\overline{CS} = 2.0\ \text{V}$, $V_{out} = 0.4\ \text{V}$ to 2.4 V)	I_{TSI}	-	-	10	μA
Supply Current ($V_{CC} = 5.25\ \text{V}$, all other pins grounded)	I_{CC}	-	-	80 100	mA
Input Capacitance (A_n , R/W, \overline{CS}_n , \overline{CS}_n) ($V_{in} = 0$, $T_A = 25^{\circ}C$, $f = 1.0\ \text{MHz}$)	C_{in}	-	-	7.5	pF
Output Capacitance (D_n) ($V_{out} = 0$, $T_A = 25^{\circ}C$, $f = 1.0\ \text{MHz}$, $CS_0 = 0$)	C_{out}	-	-	12.5	pF

RECOMMENDED DC OPERATING CONDITIONS

Parameter	Symbol	Min	Nom	Max	Unit
Input High Voltage	V_{IH}	2.0	-	5.25	Vdc
Input Low Voltage	V_{IL}	-0.3	-	0.8	Vdc

BLOCK DIAGRAM

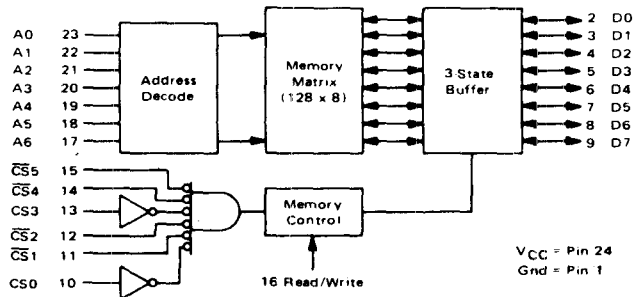

MCM6810

AC TEST CONDITIONS

Condition	Value
Input Pulse Levels	0.8 V to 2.0 V
Input Rise and Fall Times	20 ns
Output Load	See Figure 1

FIGURE 1 - AC TEST LOAD

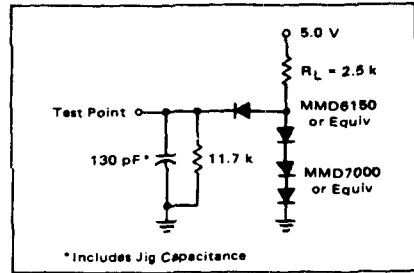

AC OPERATING CONDITIONS AND CHARACTERISTICS

READ CYCLE ($V_{CC} = 5.0 V \pm 5\%$, $V_{SS} = 0$, $T_A = T_L$ to T_H unless otherwise noted.)

Characteristic	Symbol	MCM6810		MCM68A10		MCM68B10		Unit
		Min	Max	Min	Max	Min	Max	
Read Cycle Time	$t_{cyc}(R)$	450	—	360	—	250	—	ns
Access Time	t_{acc}	—	450	—	360	—	250	ns
Address Setup Time	t_{AS}	20	—	20	—	20	—	ns
Address Hold Time	t_{AH}	0	—	0	—	0	—	ns
Data Delay Time (Read)	t_{DDR}	—	230	—	220	—	180	ns
Read to Select Delay Time	t_{RCS}	0	—	0	—	0	—	ns
Data Hold from Address	t_{DHA}	10	—	10	—	10	—	ns
Output Hold Time	t_H	10	—	10	—	10	—	ns
Data Hold from Read	t_{DHR}	10	80	10	60	10	60	ns
Read Hold from Chip Select	t_{RH}	0	—	0	—	0	—	ns

READ CYCLE TIMING

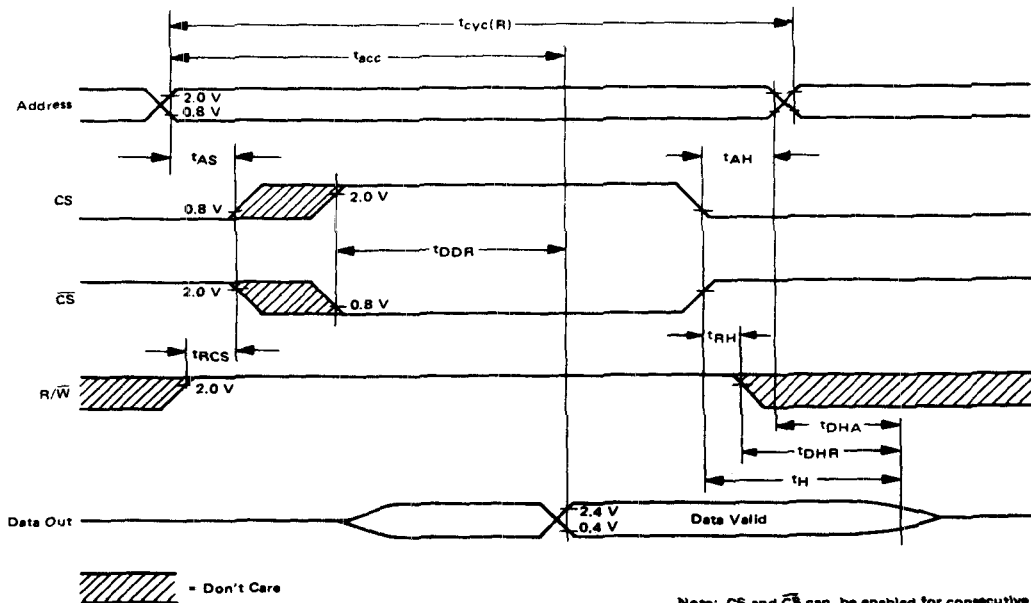

Note: CS and \overline{CS} can be enabled for consecutive read cycles provided R/W remains at V_{IH} .

MCM6810

WRITE CYCLE ($V_{CC} = 5.0 \text{ V} \pm 5\%$, $V_{SS} = 0$, $T_A = T_L$ to T_H unless otherwise noted.)

Characteristic	Symbol	MCM6810		MCM68A10		MCM68B10		Unit
		Min	Max	Min	Max	Min	Max	
Write Cycle Time	$t_{cyc}(W)$	450	--	360	--	250	--	ns
Address Setup Time	t_{AS}	20	--	20	--	20	--	ns
Address Hold Time	t_{AH}	0	--	0	--	0	--	ns
Chip Select Pulse Width	t_{CS}	300	--	250	--	210	--	ns
Write to Chip Select Delay Time	t_{WCS}	0	--	0	--	0	--	ns
Data Setup Time (Write)	t_{DSW}	190	--	80	--	60	--	ns
Input Hold Time	t_H	10	--	10	--	10	--	ns
Write Hold Time from Chip Select	t_{WH}	0	--					

WRITE CYCLE TIMING

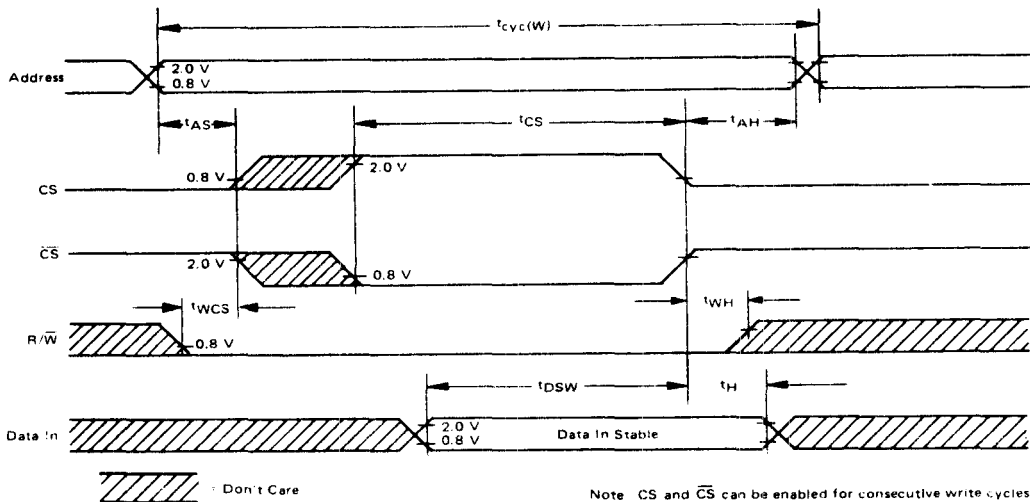

Note CS and \overline{CS} can be enabled for consecutive write cycles provided R/W is strobed to V_{IH} before or coincident with the Address change, and remains high for time t_{AS} .

PACKAGE DIMENSIONS

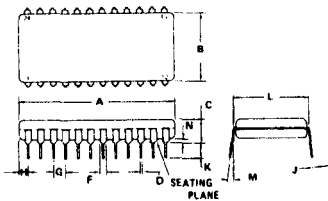

DIM	MILLIMETERS		INCHES	
	MIN	MAX	MIN	MAX
A	21.37	22.13	1.235	1.265
B	13.72	14.22	0.540	0.560
C	4.67	5.08	0.180	0.200
D	0.36	0.51	0.014	0.020
F	1.02	1.53	0.040	0.060
G	2.41	2.67	0.095	0.106
H	1.78	2.03	0.070	0.080
J	0.20	0.30	0.008	0.012
K	3.96	3.96	0.150	0.150
L	14.73	15.24	0.580	0.600
M	0.51	0.51	0.020	0.020
N	0.51	1.02	0.020	0.040

- NOTES:
 1. LEADS TRUE POSITIONED WITHIN 0.25mm (0.010) DIA. AT SEATING PLANE AT MAXIMUM MATERIAL CONDITION (DIM "D").
 2. DIM "L" TO CENTER OF LEADS WHEN FORMED PARALLEL.

CASE 709-01
(PLASTIC)

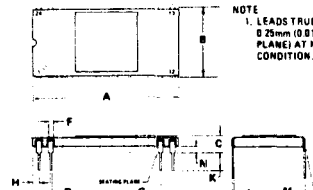

NOTE:
 1. LEADS TRUE POSITIONED WITHIN 0.25mm (0.010) DIA. AT SEATING PLANE AT MAXIMUM MATERIAL CONDITION.

DIM	MILLIMETERS		INCHES	
	MIN	MAX	MIN	MAX
A	29.97	30.99	1.180	1.220
B	16.86	18.67	0.585	0.615
C	3.06	4.19	0.120	0.165
D	0.36	0.51	0.015	0.021
F	0.76	1.40	0.030	0.055
G	2.54 BSC	0.100 BSC		
H	0.76	1.78	0.030	0.070
J	0.20	0.30	0.008	0.012
K	2.54	4.19	0.100	0.165
M	0.51	0.51	0.020	0.020
N	0.51	1.52	0.020	0.060

CASE 716-02
(CERAMIC)